



# GARDENSLIDE WAVY 304

Κυματιστή Τσουλήθρα | Garden Slide

(Οδηγίες Συναρμολόγησης | Assembly Instructions)



Μάθε περισσότερα για την  
τσουλήθρα σκανάροντας το QR

Learn more about the slide  
by scanning the QR

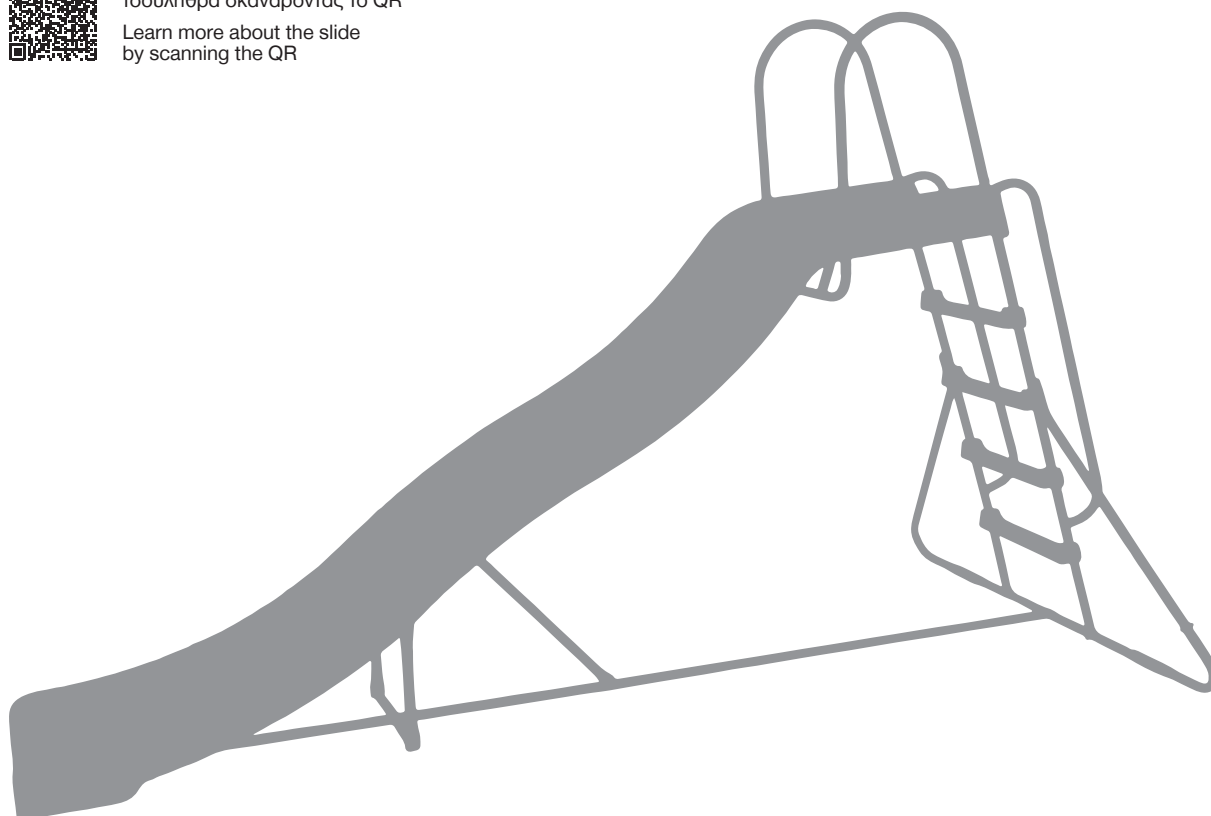

[www.amila.gr](http://www.amila.gr)





















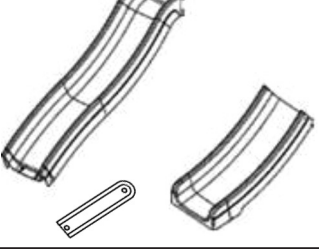





Όπου υπάρχει AMILA,  
**ΥΠΑΡΧΟΥΝ ΝΙΚΗΤΕΣ.**

ITEM NO.: 12580



Where there is AMILA,  
**THERE ARE WINNERS.**

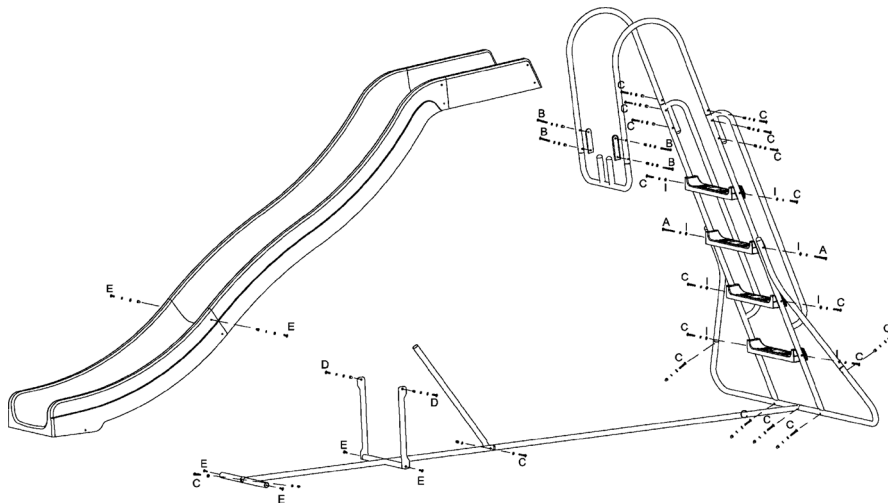

**ΛΙΣΤΑ ΕΞΑΡΤΗΜΑΤΩΝ ΣΥΝΑΡΜΟΛΟΓΗΣΗΣ | PARTS LIST**

#	TMX PCS	ΠΕΡΙΓΡΑΦΗ   DESCRIPTION	ΣΧΕΔΙΟ   DRAWING
A	2	M6 60mm bolt Βίδα M6 60mm	
B	4	M6 50mm bolt Βίδα M6 50mm	
C	19	M6 35mm bolt Βίδα M6 35mm	
D	2	M6 20mm bolt Βίδα M6 20mm	
E	6	M6 15mm bolt Βίδα M6 15mm	
F	21	M6 washer Ροδέλα M6	
G	29	M6 spring washer Γκρόβερ M6	
H	21	M6 domenut Θολωτό παξιμάδι M6	
I	8	M6 square domenut Τετράγωνο παξιμάδι M6	
J	4	Ladder step Σκαλί σκάλας	
K	1	Top wavy slide chute (with Rounded-edge) Άνω μέρος τσουλήθρας	
L	1	Middle wavy slide chute Μεσαίο μέρος τσουλήθρας	
M	1	Bottom wavy slide chute Κάτω μέρος τσουλήθρας	
M1	2	Plastic spacer Πλαστικός αποστάτης	
N	1	Tie bar Ίσια κάτω αντηρίδα	
O	1	Cross tie bar Σταυρωτή κάτω αντηρίδα	
P	1	Ladder stabilizer bar Μπάρα σταθεροποίησης σκάλας	
Q	2	L/R support bar Πλαιινές μπάρες στήριξης σκάλας	

#	TMX PCS	ΠΕΡΙΓΡΑΦΗ   DESCRIPTION	ΣΧΕΔΙΟ   DRAWING
R	2	Main handrail tube Σωλήνες σκάλας	
S	2	Top handrail tube Άνω σωλήνες σκάλας	
T	1	Support-frame of top slide chute Άνω στήριγμα σκάλας	
U	1	Support bar for middle slide chute Μεσαίο στήριγμα τσουλήθρας	
V	2	L/R support bar for bottom slide chute Μπροστινά στηρίγματα τσουλήθρας	
W	1	Support bar for bottom slide chute Άνω στήριγμα τσουλήθρας	
X	1	Spanner Κλειδί	
Y	2	Ground anchor Στερεώματα εδάφους	
Z	6	Plastic end-cap Πλαστικά καπάκια	



Παρακαλούμε, ελέγξτε προσεκτικά ότι δεν λείπει κάποιο εξάρτημα πριν ξεκινήσετε τη συναρμολόγηση. Θα χρειαστείτε επιπρόσθετα ένα κλειδί #10  και ένα σταυροκατσάβιδο .

Please make sure that no parts are missing before you begin the assembly procedure. Additionally, you will need a #10 wrench  and a philips screwdriver .

Όταν δείτε την ακόλουθη σήμανση , εκτελέστε το βήμα αυτό με τη βοήθεια κάποιου άλλου ανθρώπου.

The following icon means that you  must perform that step with the help of another person.

## ΣΥΝΑΡΜΟΛΟΓΗΣΗ | ASSEMBLY

### Step/Βήμα 1



Connect middle slide chute (L) to bottom slide chute (M).  
Ενώστε το κάτω (L) και το μεσαίο (M) μέρος της τσουλήθρας.

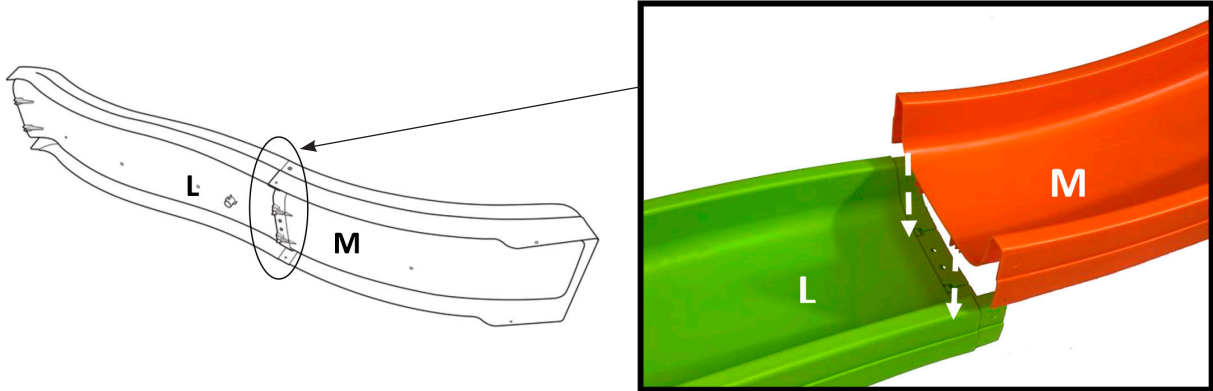

### Step/Βήμα 2

Βίδες που απαιτούνται | Screws required

E	2 x	
F	2 x	
G	2 x	
H	2 x	

Εργαλεία | Tools

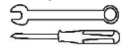



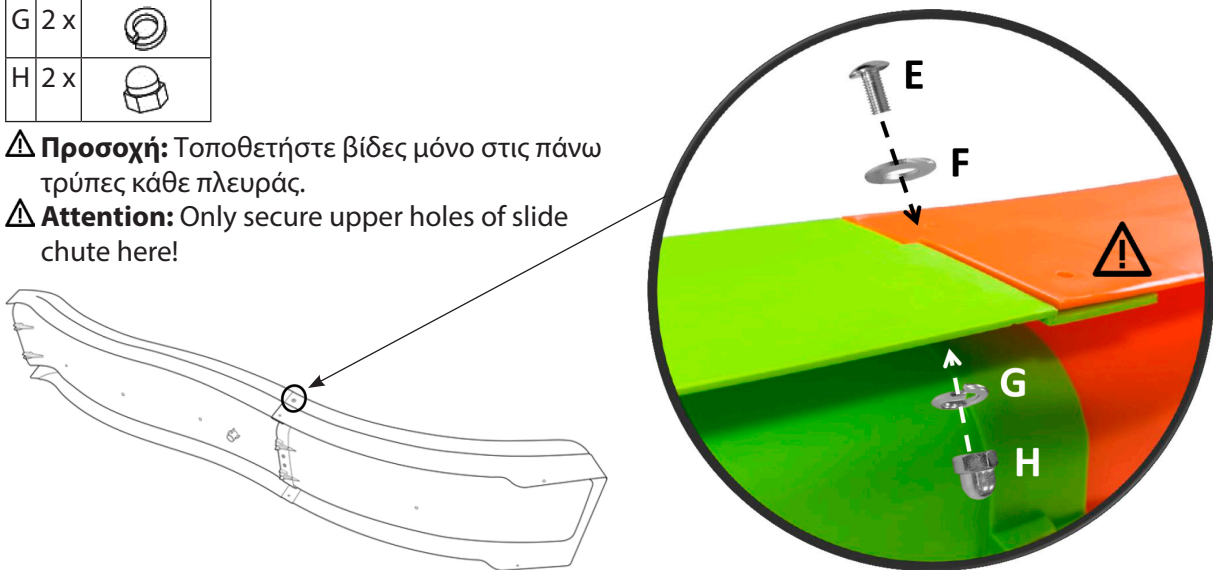

**⚠ Προσοχή:** Τοποθετήστε βίδες μόνο στις πάνω τρύπες κάθε πλευράς.

**⚠ Attention:** Only secure upper holes of slide chute here!



### Step/Βήμα 3

Βίδες που απαιτούνται | Screws required

C	1 x	
F	1 x	
G	1 x	
H	1 x	

Εργαλεία | Tools

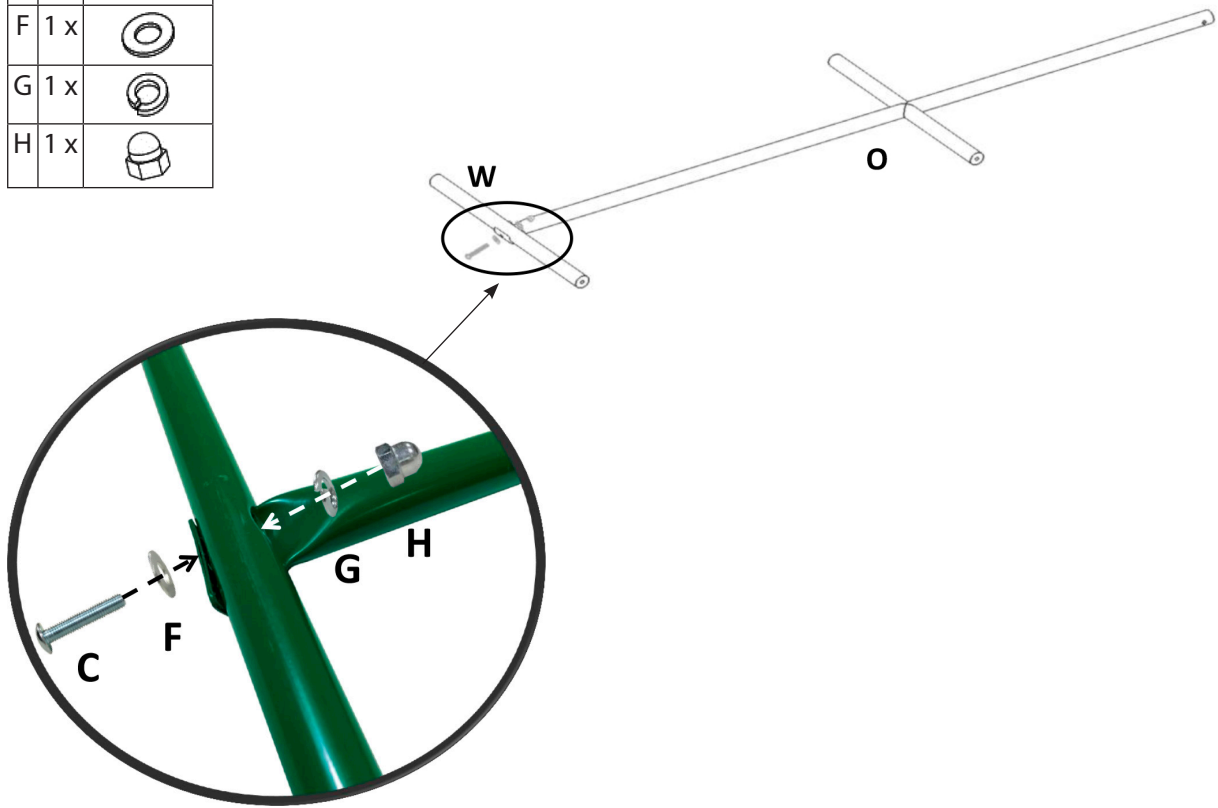
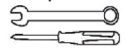

### Step/Βήμα 4

Βίδες που απαιτούνται | Screws required



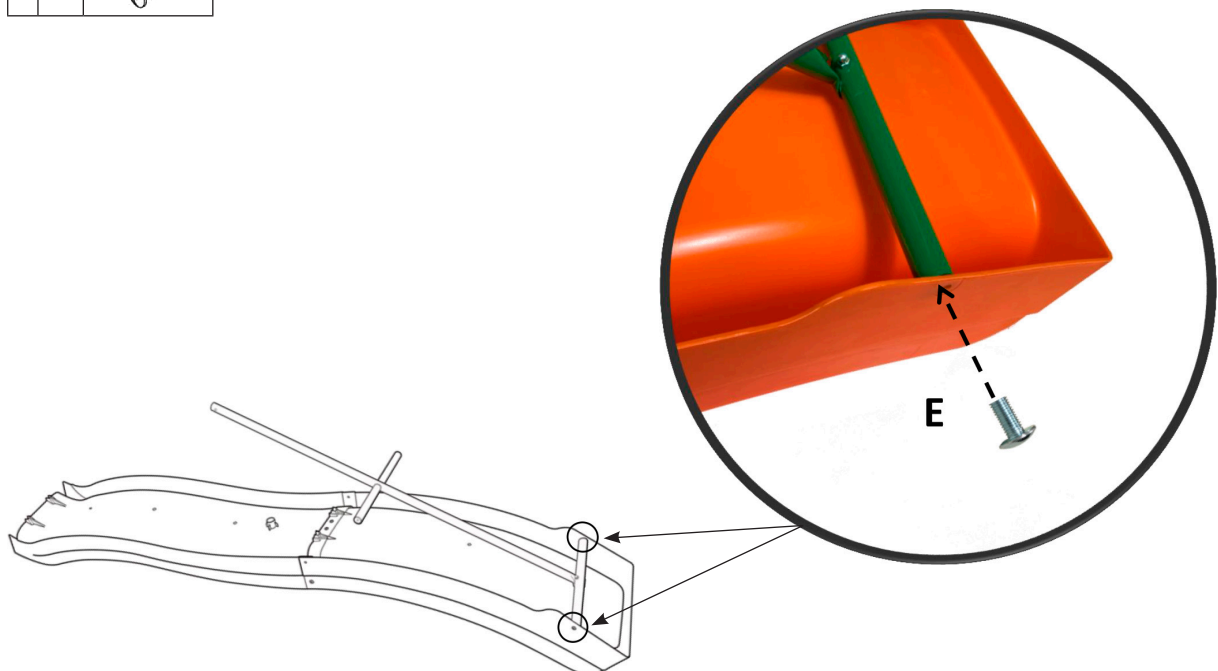
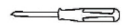

E	2 x	
---	-----	---

Εργαλεία | Tools



## Step/Βήμα 5

Βίδες που απαιτούνται | Screws required

D	2 x	
E	2 x	
F	2 x	
G	2 x	
H	2 x	

Εργαλεία | Tools

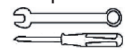

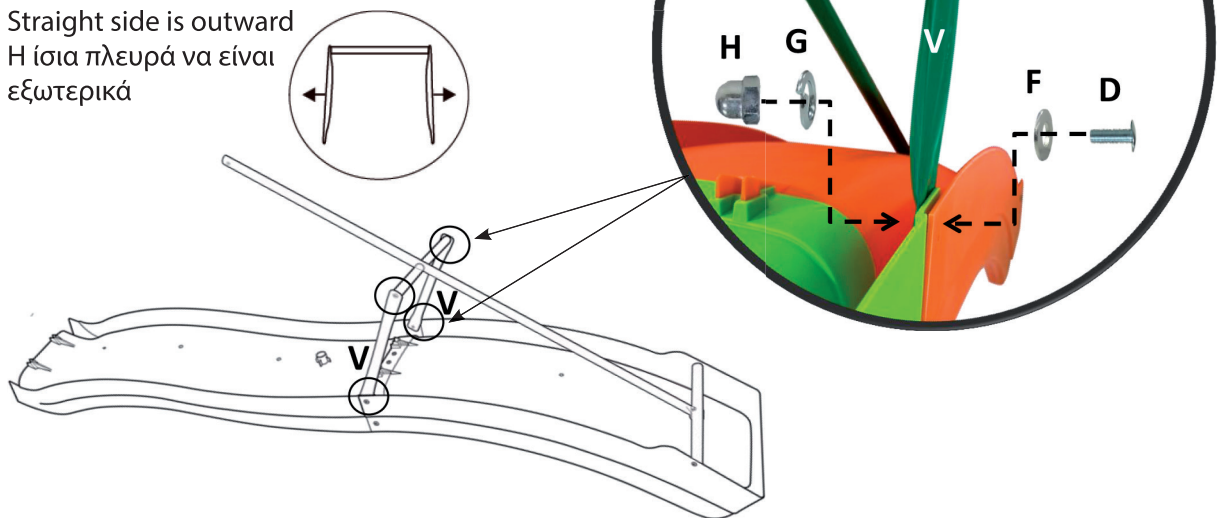

Straight side is outward  
Η ίσια πλευρά να είναι  
εξωτερικά



## Step/Βήμα 6

Βίδες που απαιτούνται | Screws required

C	6 x	
G	6 x	
I	6 x	

Εργαλεία | Tools

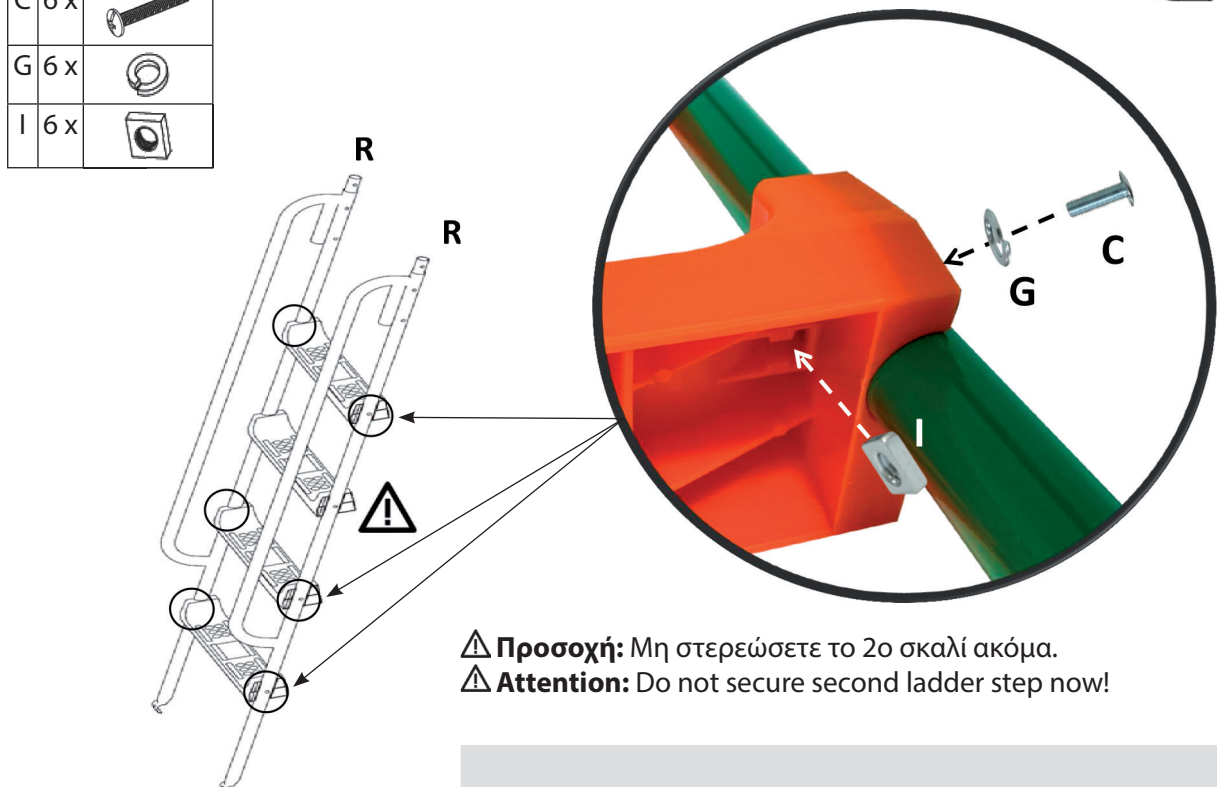
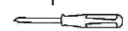

### Step/Βήμα 7



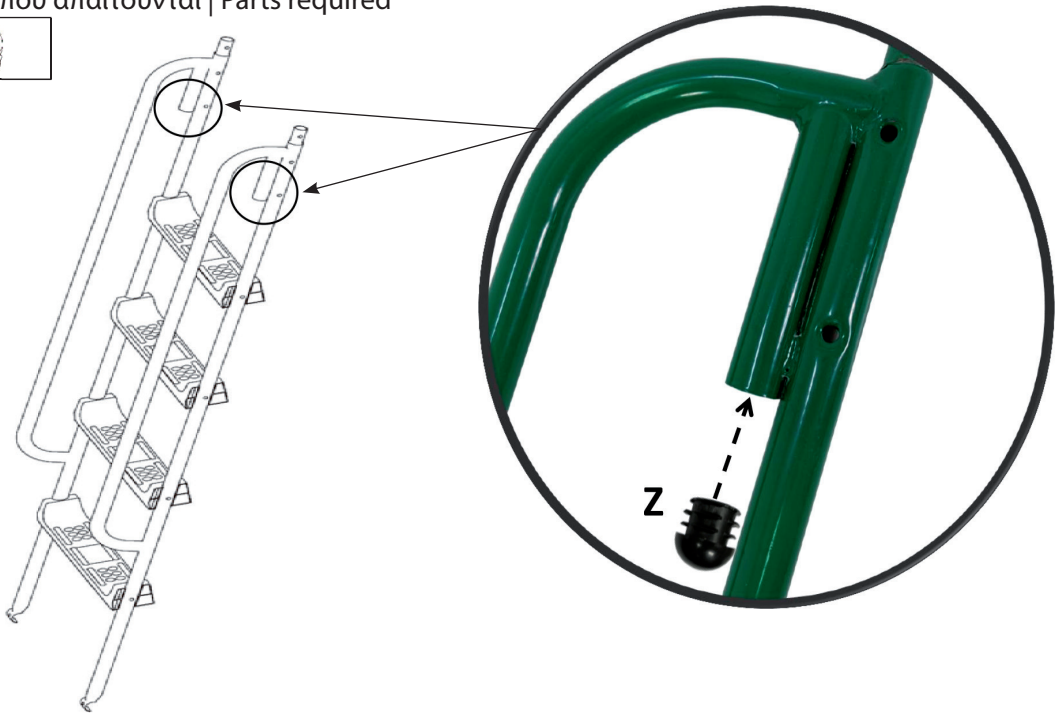

Εξαρτήματα που απαιτούνται | Parts required

Z	2 x	
---	-----	---



### Step/Βήμα 8

Βίδες που απαιτούνται | Screws required

C	2 x	
F	2 x	
G	2 x	
H	2 x	



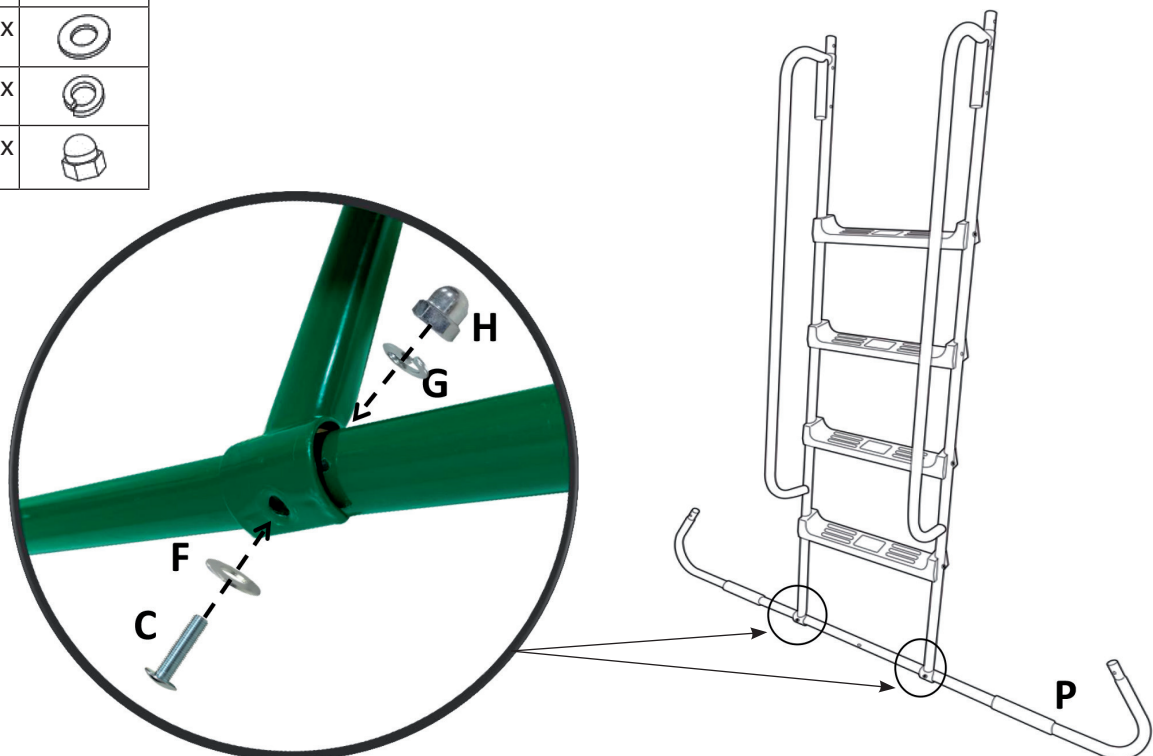

Εργαλεία | Tools





## Step/Βήμα 9

Βίδες που απαιτούνται | Screws required



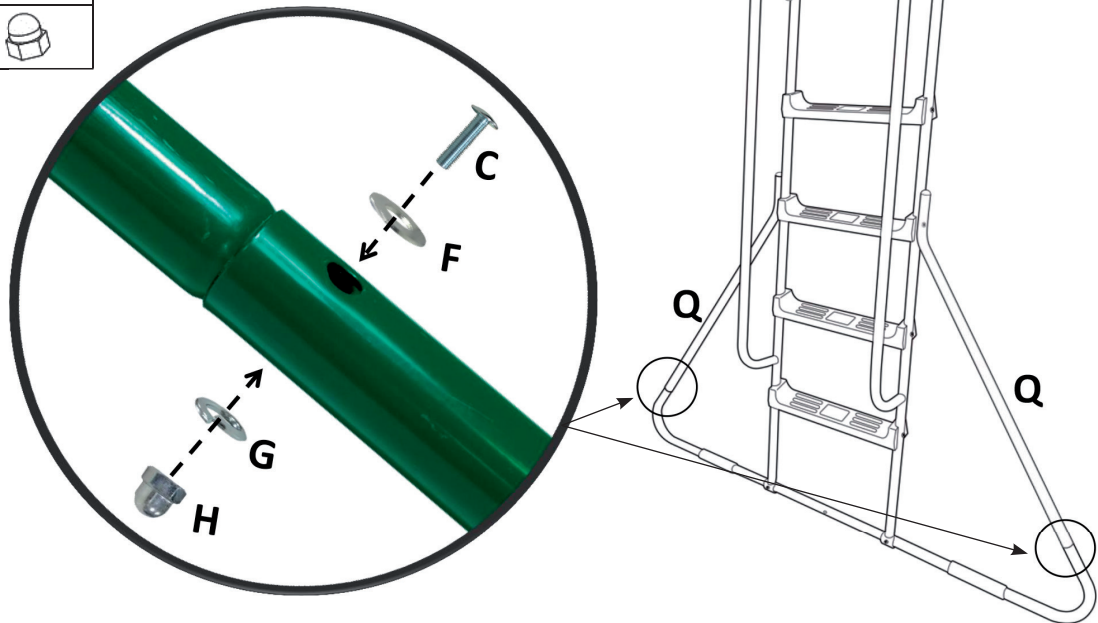
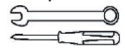

C	2 x	
F	2 x	
G	2 x	
H	2 x	

Εργαλεία | Tools



## Step/Βήμα 10

Βίδες που απαιτούνται | Screws required

A	2 x	
G	2 x	
I	2 x	
Z	2 x	

Εργαλεία | Tools

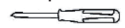

**⚠ Προσοχή:** Στο σκαλί αυτό χρησιμοποιήστε τη μεγαλύτερου μήκους βίδα «A» (M6x60mm)!



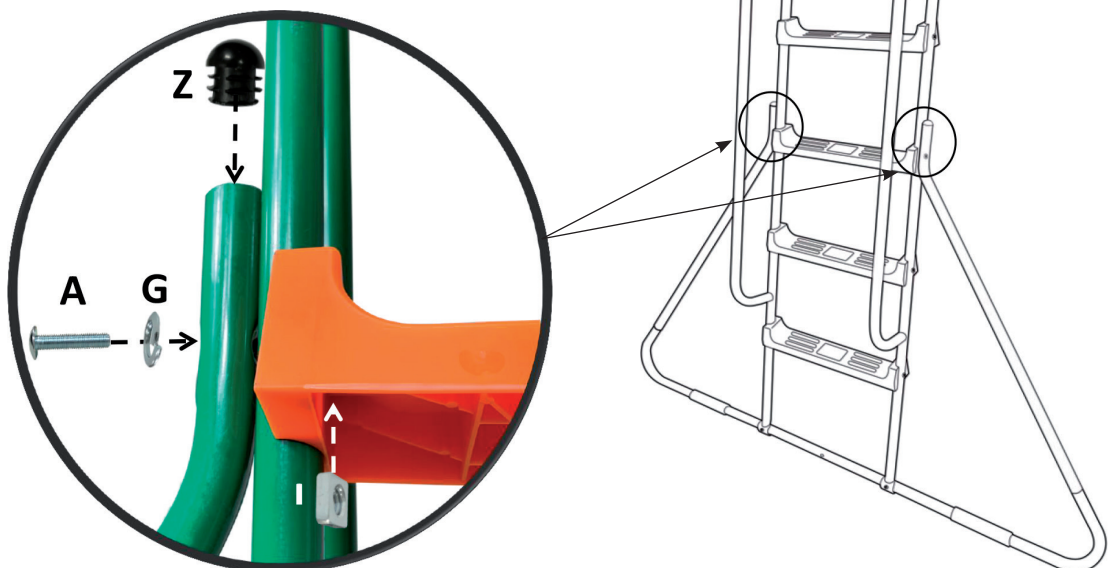

**⚠ Attention:** Use longer bolt «A» (M6x60mm) here!





### Step/Βήμα 11

Βίδες που απαιτούνται | Screws required



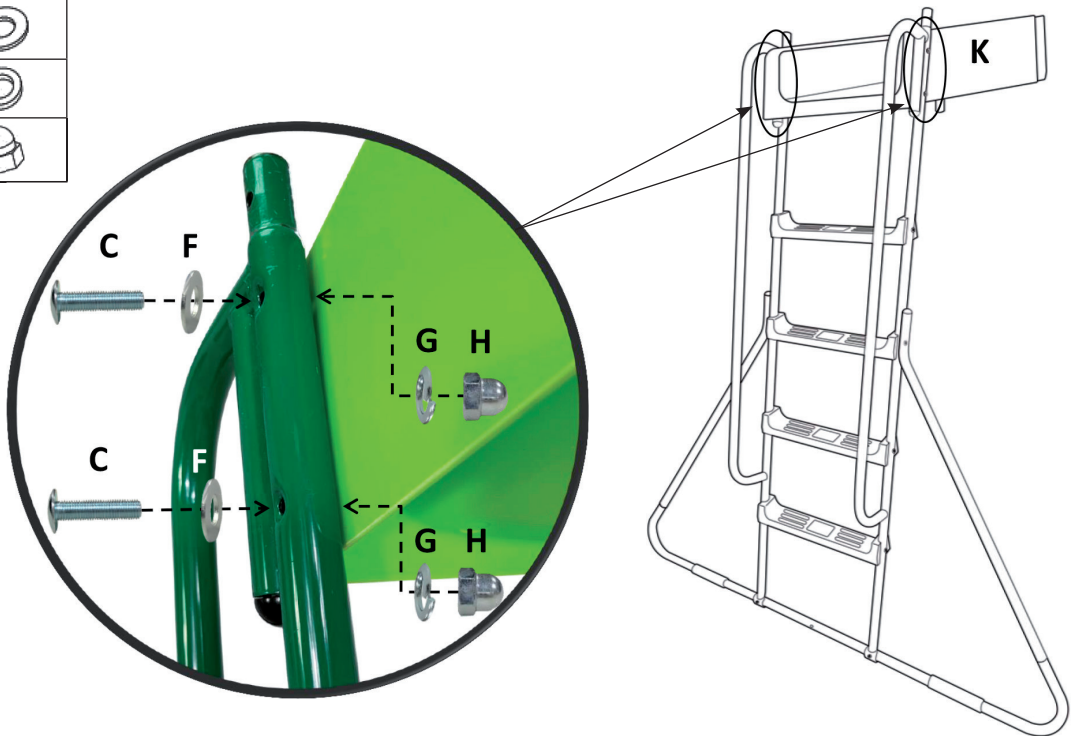
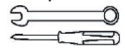

C	4 x	
F	4 x	
G	4 x	
H	4 x	

Εργαλεία | Tools



### Step/Βήμα 12

Βίδες που απαιτούνται | Screws required

C	2 x	
F	2 x	
G	2 x	
H	2 x	

Εργαλεία | Tools

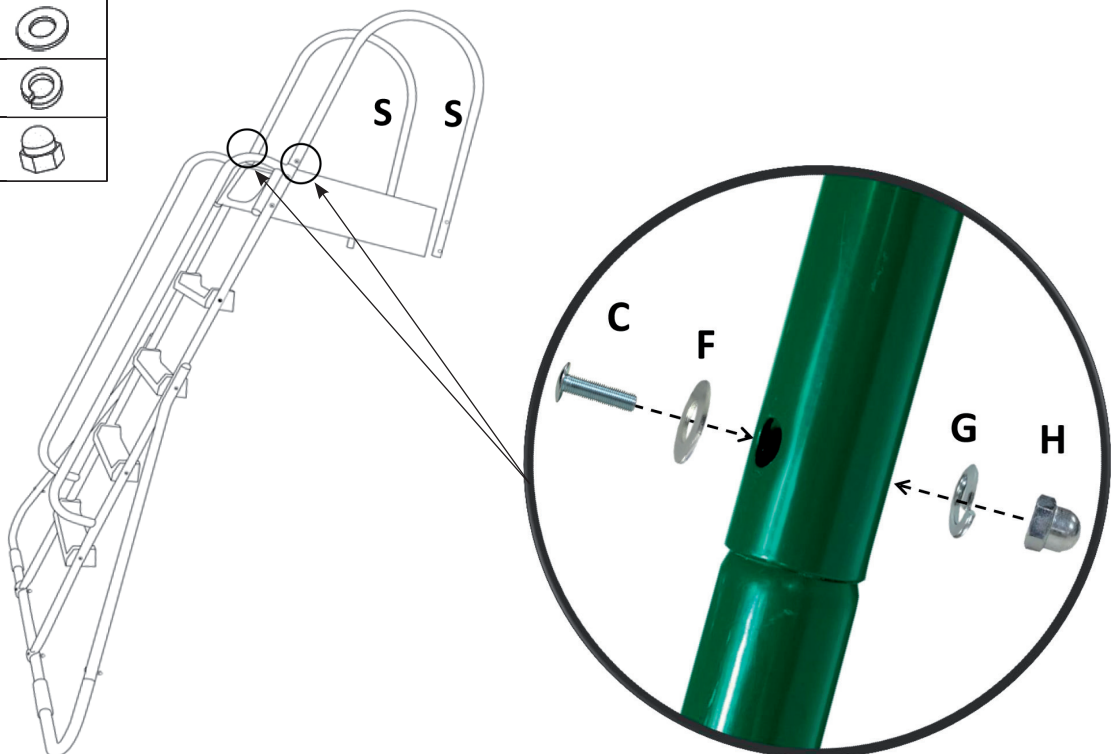
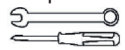

### Step/Βήμα 13



Connect middle slide chute (L) to top slide chute (K).  
Ενώστε το κάτω (L) και το επάνω (K) μέρος της τσουλήθρας.

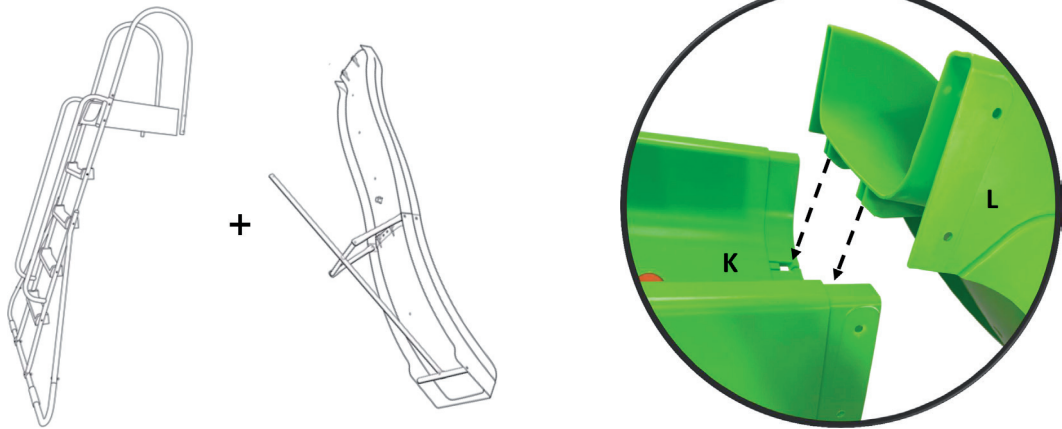

### Step/Βήμα 14

Εξαρτήματα που απαιτούνται | Parts required

T	1 x	
Z	2 x	

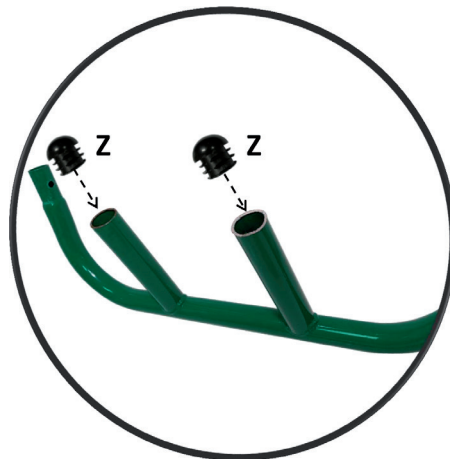

### Step/Βήμα 15

Βίδες που απαιτούνται | Screws required



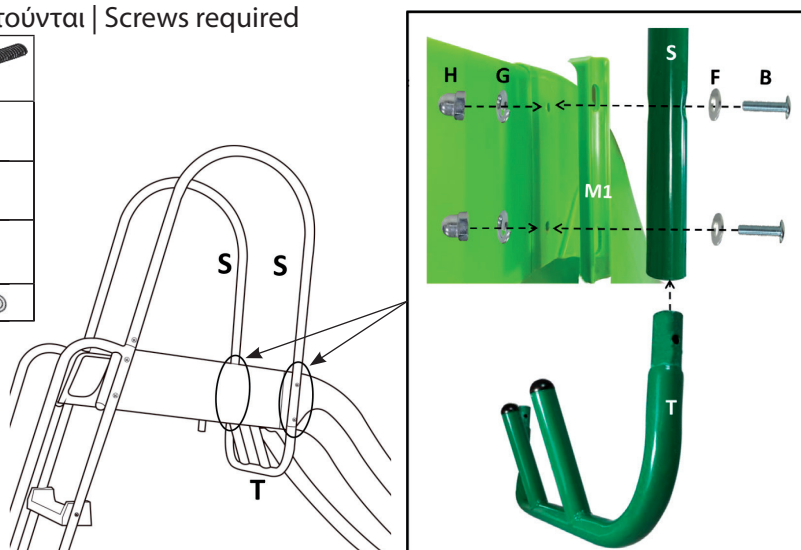
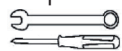

B	4 x	
F	4 x	
G	4 x	
H	4 x	
M1	2 x	

Εργαλεία | Tools



### Step/Βήμα 16

Βίδες που απαιτούνται | Screws required

C	1 x	
F	1 x	
G	1 x	
H	1 x	

Εργαλεία | Tools

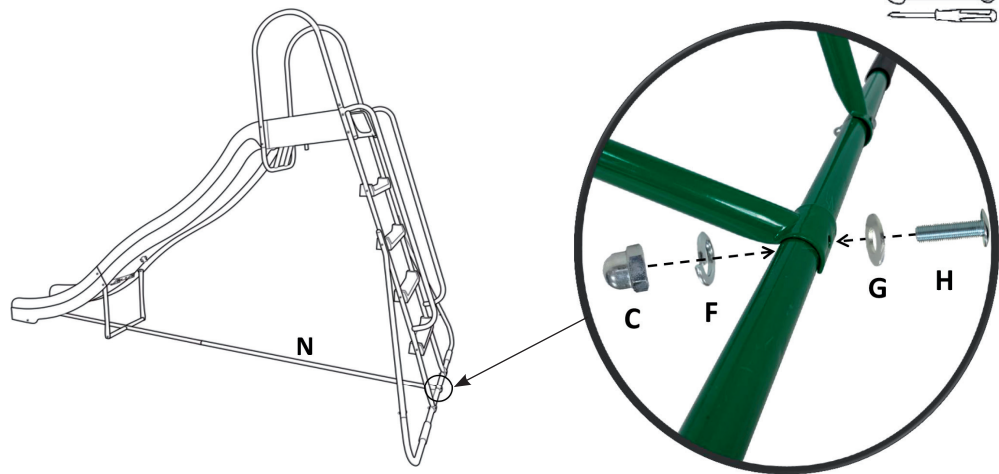
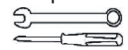

### Step/Βήμα 17



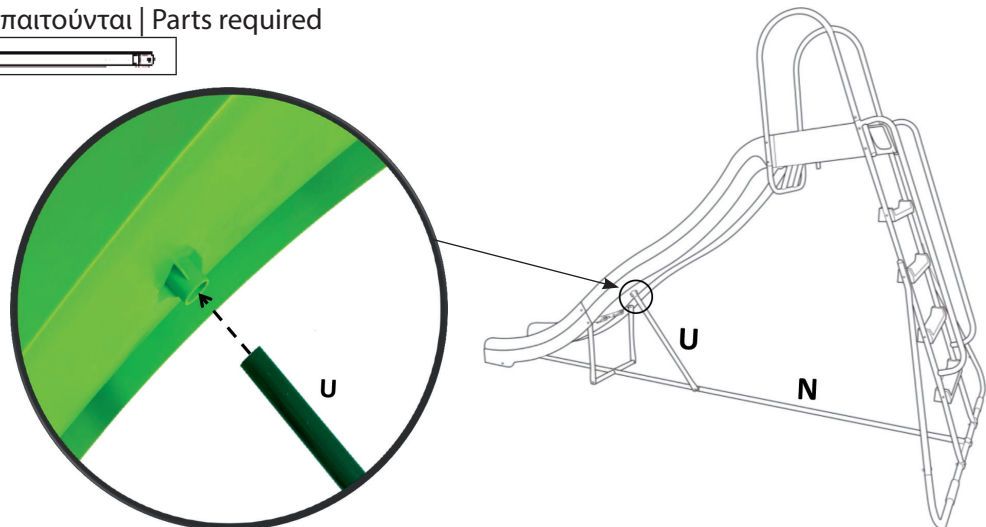

Εξαρτήματα που απαιτούνται | Parts required

U	1 x	
---	-----	---



### Step/Βήμα 18

Βίδες που απαιτούνται | Screws required

C	1 x	
F	1 x	
G	1 x	
H	1 x	

Εργαλεία | Tools

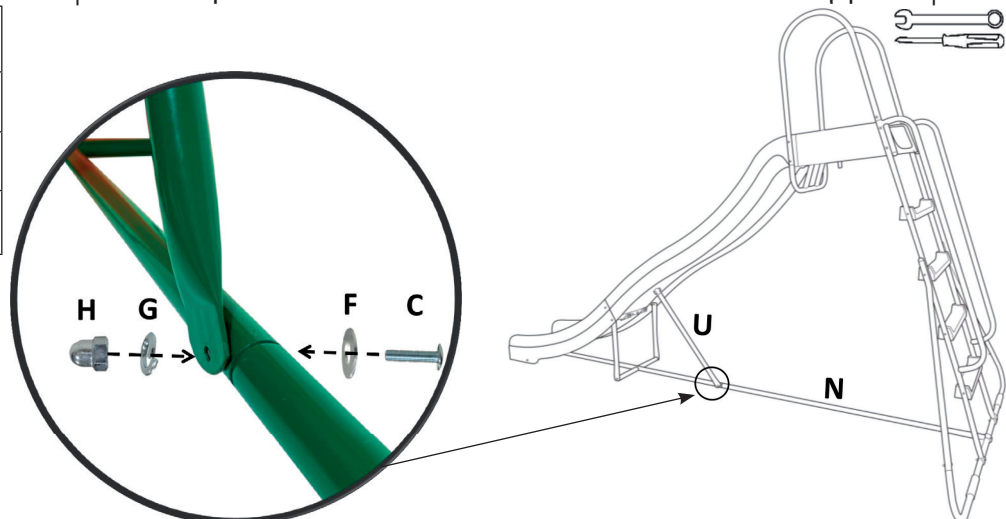
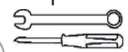

## Step/Βήμα 19

Εξαρτήματα που απαιτούνται | Parts required

Y	2 x	
---	-----	---

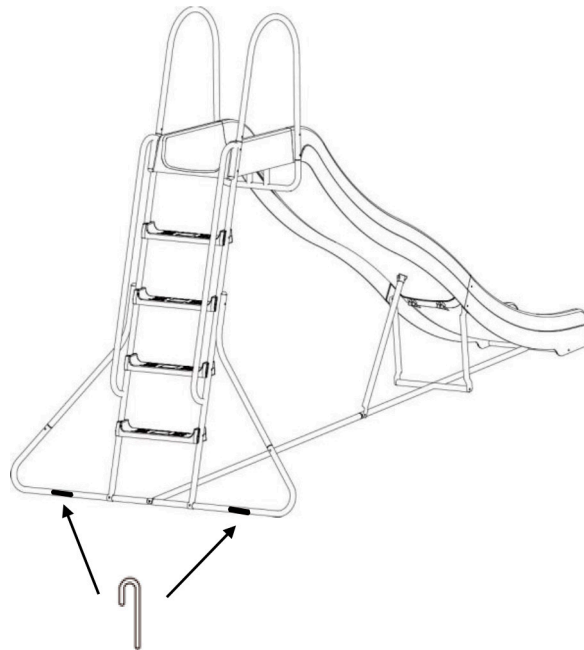

- Στερεώστε καλά στο έδαφος και τις δύο πλευρές της μπάρας σταθεροποίησης σκάλας (P) χρησιμοποιώντας στερεώματα εδάφους (Y).
- Όταν επιλέγετε το μέρος που θα τοποθετήσετε την τσουλήθρα, φροντίστε να υπάρχει τουλάχιστον 1,5 μέτρα άδειου χώρου σε κάθε πλευρά και μην την τοποθετείτε κοντά σε τοίχους, δέντρα κλπ.
- Μετά την πλήρη συναρμολόγηση, βεβαιωθείτε ότι είναι τοποθετημένη σε ασφαλές σημείο και εντελώς σταθερή. Μην την τοποθετήσετε πάνω σε χαλί.
- Μην την τοποθετήσετε μέσα σε σάουνα ή οποιαδήποτε υγρή περιοχή που μπορεί να την κάνει να σκουριάσει.
- Fix both sides of ladder stabilizer bar (P) to the ground with ground anchors (Y).
- When selecting a place to install the equipment, please leave at least 1.5m of empty space on all sides and avoid positioning the equipment near elements such as walls, treescape etc.
- Once the equipment has been assembled, please make sure that it is placed safely and completely stable. Please DO NOT place the equipment on carpet (it must be perfectly stable, not least under conditions of maximum load).
- Do not install the equipment inside the sauna or any wet area which may cause the equipment to become rusty.

**ELDICO**  
sport



Διανέμεται από την **ΕΛΔΙΚΟ ΣΠΟΡ ΜΟΝ. Α.Ε.Ε.**

Distributed by **ELDICO SPORT SA**

eMail: support@eldico.gr • Web Site: eldico.gr